

**Silicon NPN Power Transistors**

**2SD1060**

**DESCRIPTION**

- With TO-220 package
- Low collector-emitter saturation voltage
- Complement to type 2SB824

**APPLICATIONS**

- Suitable for relay drivers,high-speed Inverters,converters,and other general large-current switching applications

**PINNING**

PIN	DESCRIPTION
1	Emitter
2	Collector;connected to mounting base
3	Base

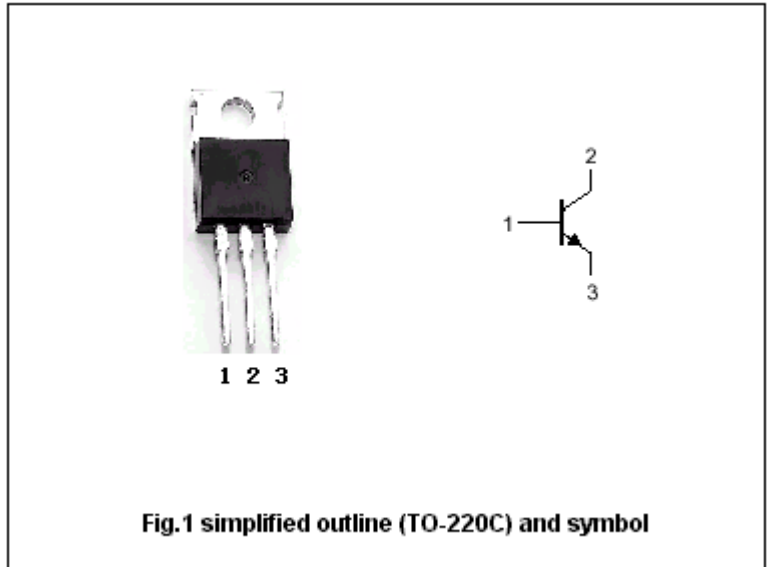

**Absolute maximum ratings (Ta=25 )**

SYMBOL	PARAMETER	CONDITIONS	VALUE	UNIT
V <sub>CB0</sub>	Collector-base voltage	Open emitter	60	V
V <sub>CEO</sub>	Collector-emitter voltage	Open base	50	V
V <sub>EBO</sub>	Emitter-base voltage	Open collector	6	V
I <sub>c</sub>	Collector current (DC)		5	A
I <sub>CP</sub>	Collector current (Pulse)		9	A
P <sub>C</sub>	Collector power dissipation	T <sub>C</sub> =25	30	W
T <sub>j</sub>	Junction temperature		150	
T <sub>stg</sub>	Storage temperature		-55~150	

## Silicon NPN Power Transistors

## 2SD1060

## CHARACTERISTICS

T<sub>j</sub>=25 unless otherwise specified

SYMBOL	PARAMETER	CONDITIONS	MIN	TYP.	MAX	UNIT
V <sub>CEO</sub>	Collector-emitter breakdown voltage	I <sub>C</sub> =1mA ;R <sub>BE</sub> =	50			V
V <sub>CBO</sub>	Collector-base breakdown voltage	I <sub>C</sub> =1mA ;I <sub>E</sub> =0	60			V
V <sub>EBO</sub>	Emitter-base breakdown voltage	I <sub>E</sub> =1mA ;I <sub>C</sub> =0	6			V
V <sub>CEsat</sub>	Collector-emitter saturation voltage	I <sub>C</sub> =3A; I <sub>B</sub> =0.3A			0.4	V
I <sub>CBO</sub>	Collector cut-off current	V <sub>CB</sub> =40V;I <sub>E</sub> =0			0.1	mA
I <sub>EBO</sub>	Emitter cut-off current	V <sub>EB</sub> =4V; I <sub>C</sub> =0			0.1	mA
h <sub>FE-1</sub>	DC current gain	I <sub>C</sub> =1A ; V <sub>CE</sub> =2V	70		280	
h <sub>FE-2</sub>	DC current gain	I <sub>C</sub> =3A ; V <sub>CE</sub> =2V	30			
C <sub>OB</sub>	Output capacitance	I <sub>E</sub> =0 ; V <sub>CB</sub> =10V;f=1MHz		100		pF
f <sub>T</sub>	Transition frequency	I <sub>C</sub> =1A ; V <sub>CE</sub> =-5V		30		MHz

## Switching times

t <sub>on</sub>	Turn-on time	I <sub>C</sub> =2.0A; I <sub>B1</sub> = I <sub>B2</sub> =0.2A		0.1		μs
t <sub>s</sub>	Storage time			1.4		μs
t <sub>f</sub>	Fall time			0.2		μs

◆ h<sub>FE-1</sub> classifications

Q	R	S
70-140	100-200	140-280

Silicon NPN Power Transistors

2SD1060

PACKAGE OUTLINE

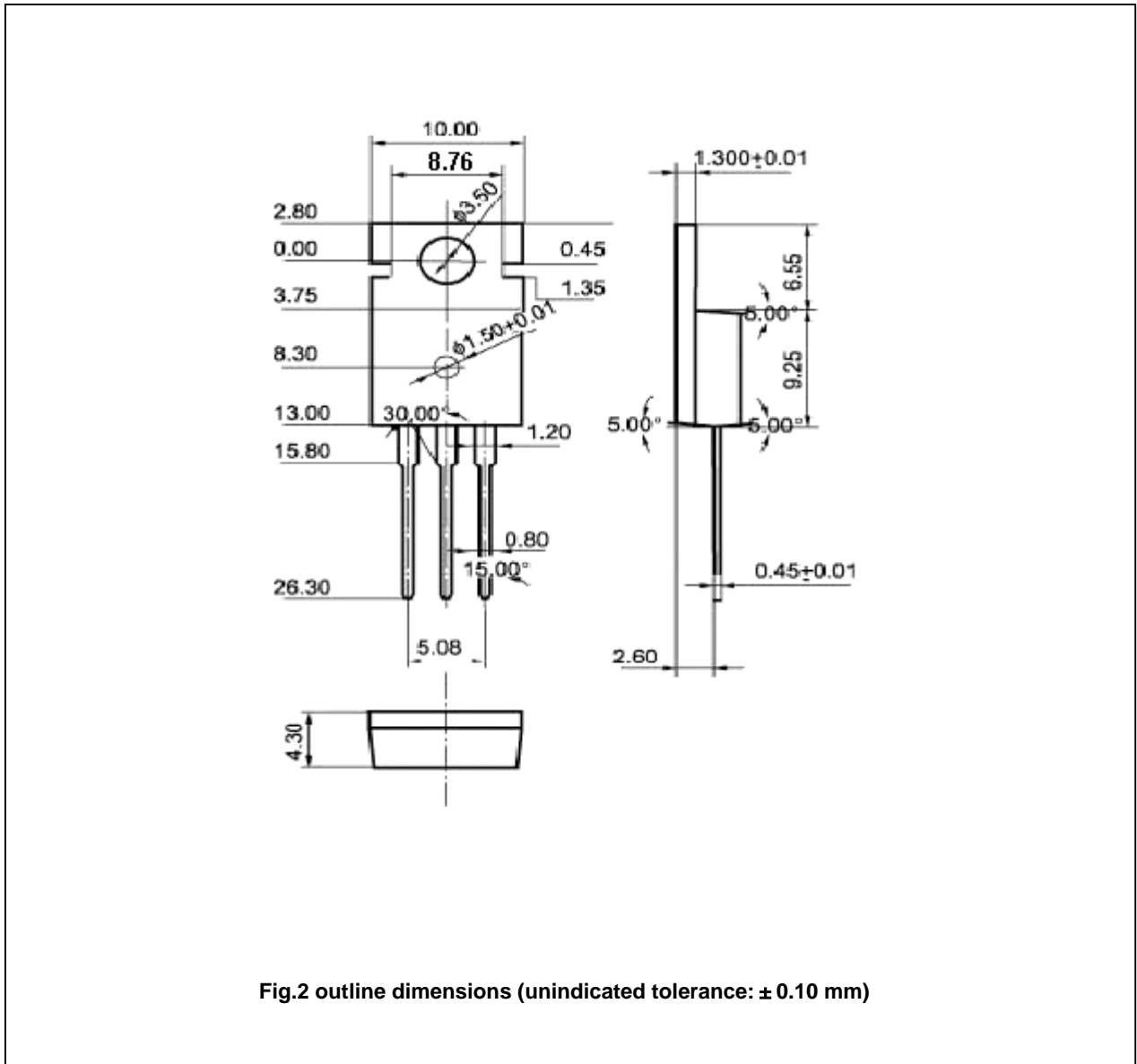

Fig.2 outline dimensions (unindicated tolerance: ± 0.10 mm)

Silicon NPN Power Transistors

2SD1060

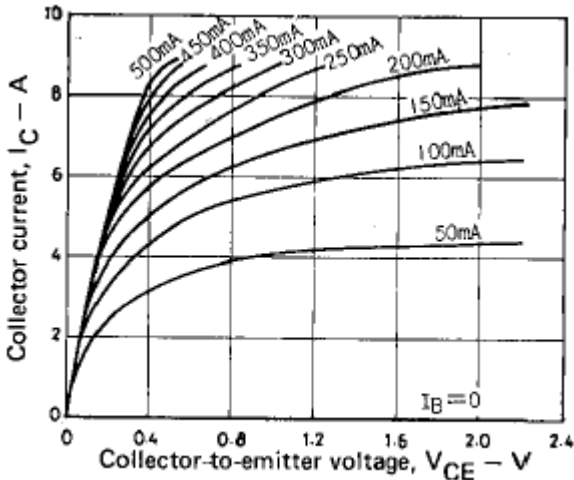

Fig.3 Static Characteristic

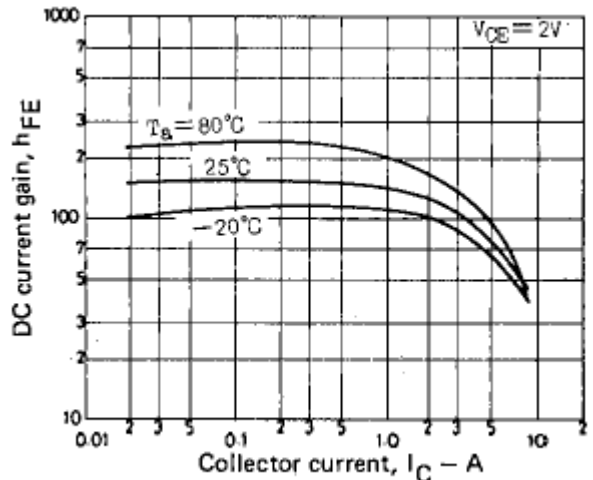

Fig.4 DC current Gain

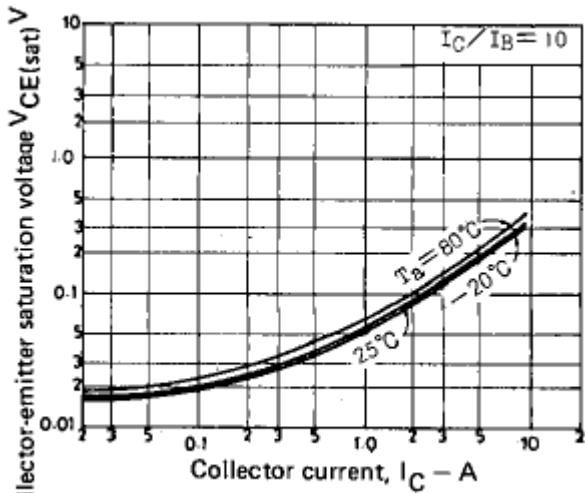

Fig.5 Collector-Emitter Saturation Voltage

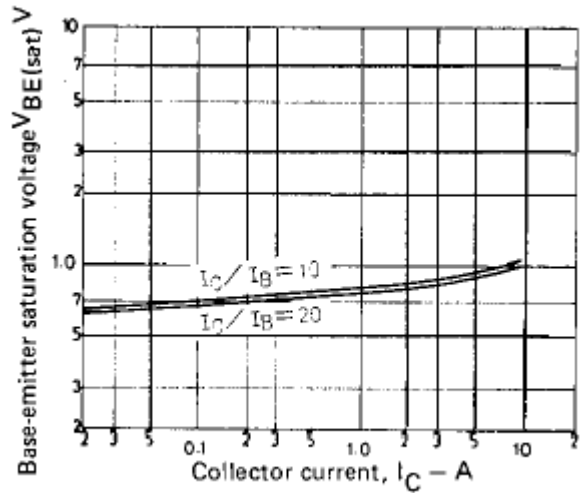

Fig.6 Base-Emitter Saturation Voltage

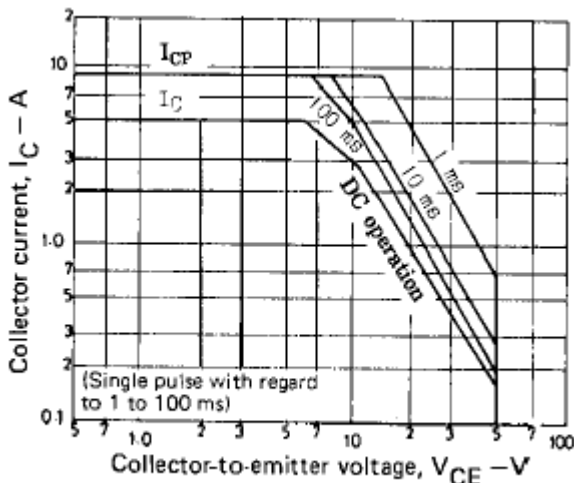

Fig.7 Safe Operating Area